

Article number: 03215035

Description: Fluro Rod End GILRS 35-R

Housing and ball in stainless steel with left-handed thread

Measures

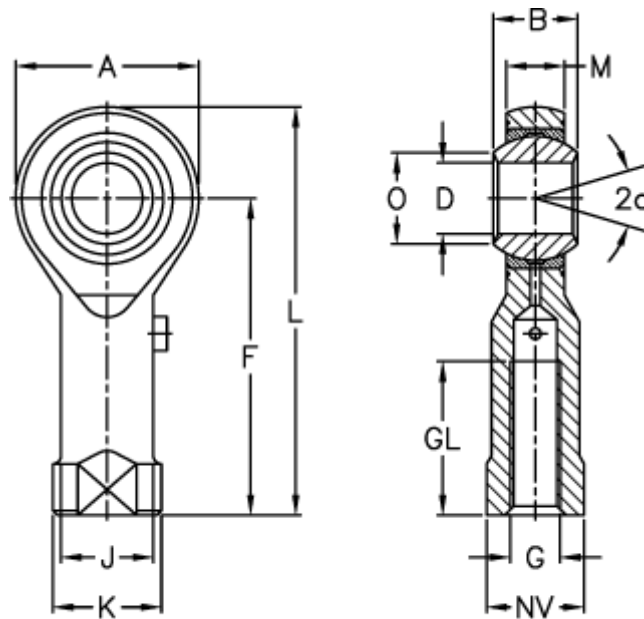

Str. 3 uden smørenippel

A	= 80	J	= 46	Weight (g) = 1600
a (degrees)	= 19	K	= 58	
B	= 43	L	= 165	
D	= 35	M	= 28	
Dynamic load C (kN)	= 80	NV	= 50	
F	= 125	O	= 37.7	
G	= M36x2	Permissible rpm	= 330	
GL	= 56	Static load C0 (kN)	= 191	